

# LP4950C-5V and LP4951C Adjustable Micropower Voltage Regulators

## General Description

The LP4950C and LP4951C are micropower voltage regulators with very low quiescent current (75 $\mu$ A typ.) and very low dropout voltage (typ. 40mV at light loads and 380mV at 100mA). They are ideally suited for use in battery-powered systems. Furthermore, the quiescent current of the LP4950C/LP4951C increases only slightly in dropout, prolonging battery life.

The LP4950C in the popular 3-pin TO-92 package is pin compatible with older 5V regulators. The 8-lead LP4951C is available in a plastic surface mount package and offers additional system functions.

One such feature is an error flag output which warns of a low output voltage, often due to falling batteries on the input. It may be used for a power-on reset. A second feature is the logic-compatible shutdown input which enables the regulator to be switched on and off. Also, the part may be pin-strapped for a 5V output or programmed from 1.24V to 29V with an external pair of resistors.

Careful design of the LP4950C/LP4951C has minimized all contributions to the error budget. This includes a tight initial

tolerance (.5% typ.), extremely good load and line regulation (.05% typ.) and a very low output voltage temperature coefficient, making the part useful as a low-power voltage reference.

## Features

- High accuracy 5V guaranteed 100mA output
- Extremely low quiescent current
- Low dropout voltage
- Extremely tight load and line regulation
- Very low temperature coefficient
- Use as Regulator or Reference
- Needs only 1 $\mu$ F for stability
- Current and Thermal Limiting

## LP4951C versions only

- Error flag warns of output dropout
- Logic-controlled electronic shutdown
- Output programmable from 1.24 to 29V

## Block Diagram and Typical Applications

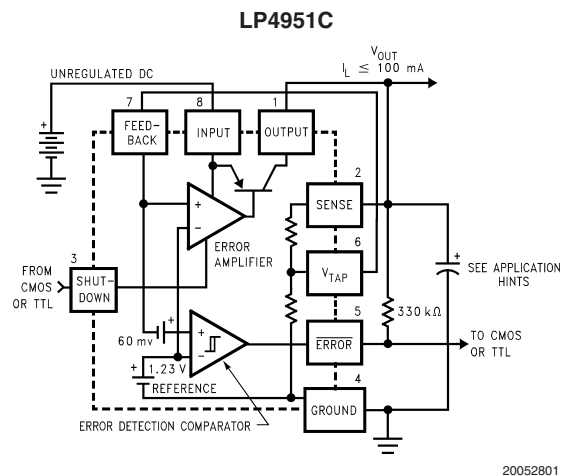
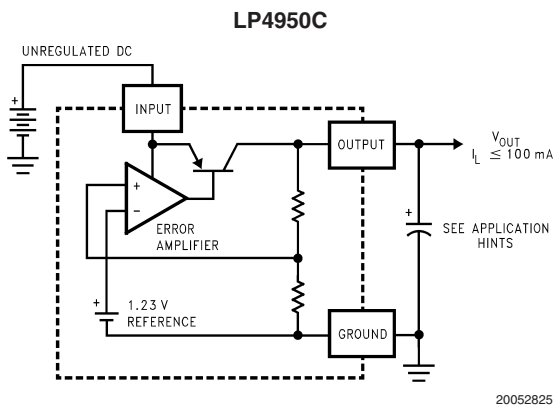

### Absolute Maximum Ratings (Note 1)

If Military/Aerospace specified devices are required, please contact the National Semiconductor Sales Office/Distributors for availability and specifications.

Input Supply Voltage	-0.3 to +30V
SHUTDOWN Input Voltage, Error Comparator Output Voltage, (Note 9)	-0.3 to +30V
FEEDBACK Input Voltage (Note 9) (Note 10)	-1.5 to +30V
Power Dissipation	Internally Limited
Junction Temperature (T <sub>J</sub> )	+150°C
Ambient Storage Temperature	-65° to +150°C

Soldering Dwell Time, Temperature

Wave	4 seconds, 260°C
Infrared	10 seconds, 240°C
Vapor Phase	75 seconds, 219°C
ESD	TBD

### Operating Ratings (Note 1)

Maximum Input Supply Voltage	30V
Junction Temperature Range (Note 8)	-40°C to 125°C
LP4950C, LP4951C	

### Electrical Characteristics (Note 2)

Parameter	Conditions (Note 2)	LP4950CZ LP4951CM			Units
		Typ	Tested Limit (Note 3)	Design Limit (Note 4)	
Output Voltage	T <sub>J</sub> = 25°C	5.0	5.1 4.9		V max V min
	-25°C ≤ T <sub>J</sub> ≤ 85°C			5.15 4.85	V max V min
	Full Operating Temperature Range			<b>5.2</b> <b>4.8</b>	V max V min
Output Voltage	100 μA ≤ I <sub>L</sub> ≤ 100 mA T <sub>J</sub> ≤ T <sub>JMAX</sub>			<b>5.24</b> <b>4.76</b>	V max V min
	(Note 12)			<b>150</b>	ppm/°C
Line Regulation (Note 14)	6V ≤ V <sub>IN</sub> ≤ 30V (Note 15)	0.04	0.2	<b>0.4</b>	% max % max
Load Regulation (Note 14)	100μA ≤ I <sub>L</sub> ≤ 100mA	0.1	0.2	<b>0.3</b>	% max % max
Dropout Voltage (Note 5)	I <sub>L</sub> = 100μA	50	80	<b>150</b>	mV max mV max
	I <sub>L</sub> = 100mA	380	450	<b>600</b>	mV max mV max
Ground Current	I <sub>L</sub> = 100μA	75	150	<b>170</b>	μA max μA max
	I <sub>L</sub> = 100mA	8	15	<b>19</b>	mA max mA max
Dropout Ground Current	V <sub>IN</sub> = 4.5V I <sub>L</sub> = 100μA	110	200	<b>230</b>	μA max μA max
Current Limit	V <sub>OUT</sub> = 0	160	200	<b>220</b>	mA max mA max
Thermal Regulation	(Note 13)	0.05	0.2		%/W max
Output Noise, 10 Hz to 100 kHz	C <sub>L</sub> = 1μF	430			μV rms
	C <sub>L</sub> = 200μF	160			μV rms
	C <sub>L</sub> = 3.3μF (Bypass = 0.01μF Pins 7 to 1 (LP4951C))	100			μV rms

## Electrical Characteristics

		LP4951C				
Parameter	Conditions (Note 2)	Typ	Tested Limit (Note 3)	Desgin Limit (Note 4)	Units	
<b>8-PIN VERSIONS ONLY</b>						
Reference Voltage		1.235	1.285	<b>1.295</b>	V max V max V min Vmin	
Reference Voltage	(Note 7)		1.185	<b>1.165</b>	V max V min	
Feedback Pin Bias Current		20	40	<b>60</b>	nA max nA max	
Reference Voltage Temperature Coefficient	(Note 12)	50			ppm/°C	
Feedback Pin Bias Current Temperature Coefficient		0.1			nA/°C	
<b>Error Comparator</b>						
Output Leakage Current	VOH = 30V	0.01	1	<b>2</b>	μA max μA max	
Output Low Voltage	V <sub>IN</sub> = 4.5V I <sub>OL</sub> = 400μA	150	250	<b>400</b>	mV max mV max	
Upper Threshold Voltage	(Note 4)	60	40	<b>25</b>	mV min mV min	
Lower Threshold Voltage	(Note 6)	75	95	<b>140</b>	mV max mV max	
Hysteresis	(Note 6)	15			mV	
<b>Shutdown Input</b>						
Input Logic Voltage		1.3			V	
	Low (Regulator ON)				<b>0.7</b>	V max
	High (Regulator OFF)				<b>2.0</b>	V min
Shutdown Pin Input Current	V <sub>SHUTDOWN</sub> = 2.4V	30	50	<b>100</b>	μA max μA max	
	V <sub>SHUTDOWN</sub> = 30V	450	600	<b>750</b>	μA max μA max	
Regulator Output Current in Shutdown	(Note 11)	3	10	<b>20</b>	μA max μA max	

**Note 1:** Absolute Maximum Ratings are limits beyond which damage to the device may occur. Operating Ratings are conditions under which operation of the device is guaranteed. Operating Ratings do not imply guaranteed performance limits. For guaranteed performance limits and associated test conditions, see the Electrical Characteristics tables.

**Note 2:** Unless otherwise specified all limits guaranteed for V<sub>IN</sub> = 6V, I<sub>L</sub> = 100μA and C<sub>L</sub> = 1μF. Limits appearing in **boldface** type apply over the entire junction temperature range for operation. Limits appearing in normal type apply for T<sub>A</sub> = T<sub>J</sub> = 25°C. Additional conditions for the 8-pin versions are FEEDBACK tied to V<sub>TAP</sub>, OUTPUT tied to SENSE (V<sub>OUT</sub> = 5V), and V<sub>SHUTDOWN</sub> ≤ 0.8V.

**Note 3:** Guaranteed and 100% production tested.

**Note 4:** Guaranteed but not 100% production tested. These limits are not used to calculate outgoing AQL levels.

**Note 5:** Dropout Voltage is defined as the input to output differential at which the output voltage drops 100 mV below its nominal value measured at 1V differential. At very low values of programmed output voltage, the minimum input supply voltage of 2V (2.3V over temperature) must be taken into account.

**Note 6:** Comparator thresholds are expressed in terms of a voltage differential at the Feedback terminal below the nominal reference voltage measured at V<sub>IN</sub> = 6V. To express these thresholds in terms of output voltage change, multiply by the error amplifier gain = V<sub>OUT</sub>/V<sub>REF</sub> = (R1 + R2)/R2. For example, at a programmed output voltage of 5V, the Error output is guaranteed to go low when the output drops by 95 mV × 5V/1.235V = 384 mV. Thresholds remain constant as a percent of V<sub>OUT</sub> as V<sub>OUT</sub> is varied, with the dropout warning occurring at typically 5% below nominal, 7.5% guaranteed.

**Note 7:** V<sub>REF</sub> ≤ V<sub>OUT</sub> ≤ (V<sub>IN</sub> - 1V), 2.3V ≤ V<sub>IN</sub> ≤ 30V, 100μA ≤ I<sub>L</sub> ≤ 100mA, T<sub>J</sub> ≤ T<sub>JMAX</sub>.

**Note 8:** The junction-to-ambient thermal resistances are as follows: 180°C/W and 160°C/W for the TO-92 package with 0.40 inch and 0.25 inch leads to the printed circuit board (PCB) respectively, 160°C/W for the molded plastic SOP (M). The above thermal resistances for the M package apply when the package is soldered directly to the PCB.

## Electrical Characteristics (Continued)

**Note 9:** May exceed input supply voltage.

**Note 10:** When used in dual-supply systems where the output terminal sees loads returned to a negative supply, the output voltage should be diode-clamped to ground.

**Note 11:**  $V_{SHUTDOWN} \geq 2V$ ,  $V_{IN} \leq 30V$ ,  $V_{OUT} = 0$ , Feedback pin tied to  $V_{TAP}$ .

**Note 12:** Output or reference voltage temperature coefficient is defined as the worst case voltage change divided by the total temperature range.

**Note 13:** Thermal regulation is defined as the change in output voltage at a time T after a change in power dissipation is applied, excluding load or line regulation effects. Specifications are for a 50 mA load pulse at  $V_{IN} = 30V$  (1.25W pulse) for  $T = 10ms$ .

**Note 14:** Regulation is measured at constant junction temperature, using pulse testing with a low duty cycle. Changes in output voltage due to heating effects are covered under the specification for thermal regulation.

**Note 15:** Line regulation for the LP4951C is tested at  $150^{\circ}C$  for  $I_L = 1 mA$ . For  $I_L = 100\mu A$  and  $T_J = 125^{\circ}C$ , line regulation is guaranteed by design to 0.2%. See Typical Performance Characteristics for line regulation versus temperature and load current.

## Connection Diagrams

**TO-92 Plastic Package (Z)**

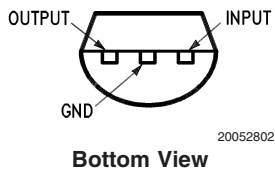

**Surface-Mount Package (M)**

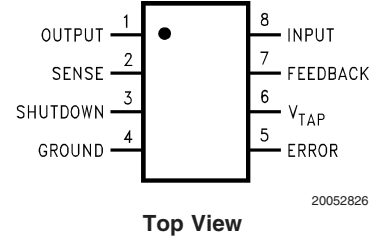

## Ordering Information

Package	Output Voltage	Temperature
	5.0V	
TO-92 (Z)	LP4950CZ-5.0	$-40^{\circ}C < T_J < 125^{\circ}C$
M (M08A)	LP4951CM	$-40^{\circ}C < T_J < 125^{\circ}C$

# Typical Performance Characteristics

**Quiescent Current**

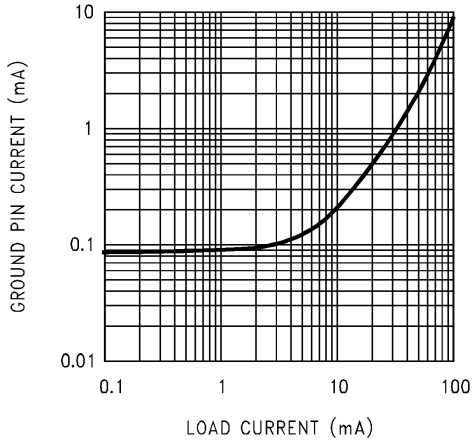

20052827

**Dropout Characteristics**

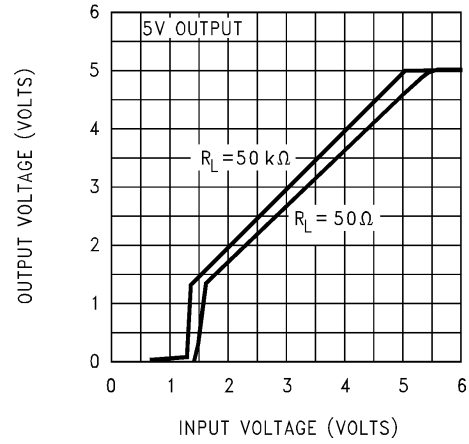

20052828

**Input Current**

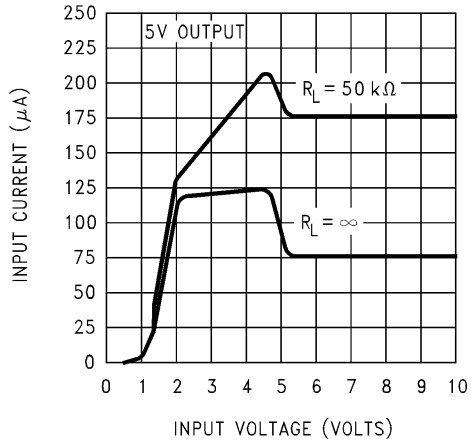

20052829

**Input Current**

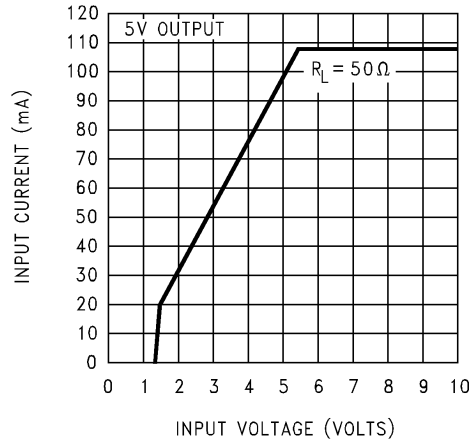

20052830

**Output Voltage vs. Temperature of 3 Representative Units**

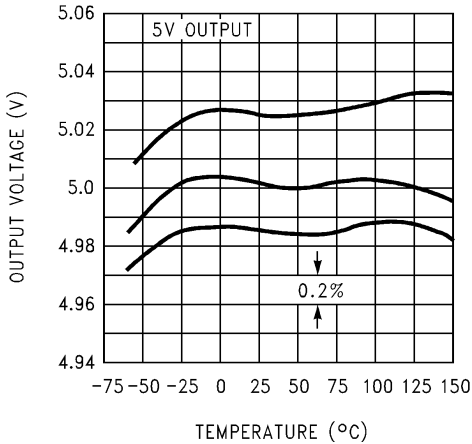

20052831

**Quiescent Current**

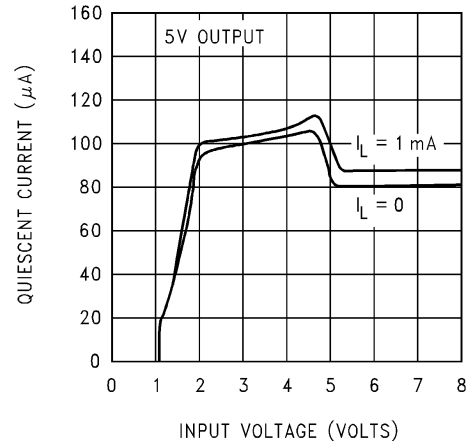

20052832

Typical Performance Characteristics (Continued)

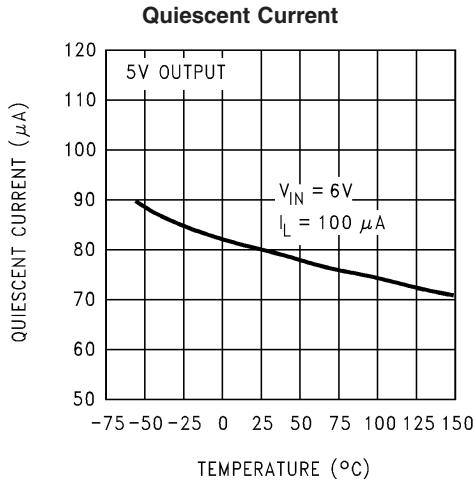

20052833

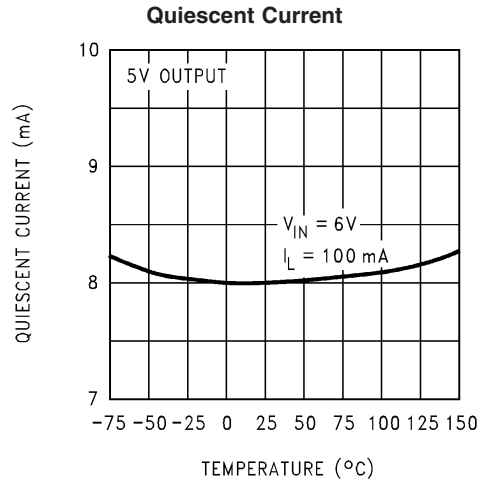

20052834

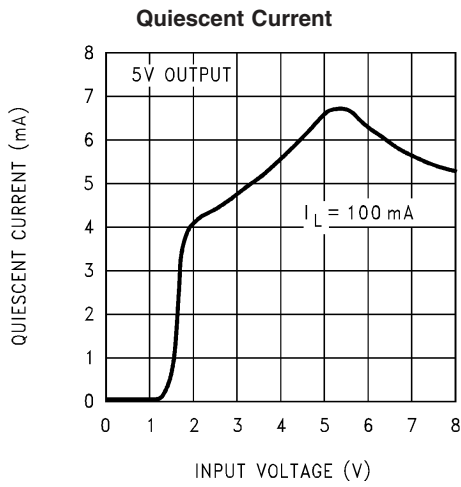

20052835

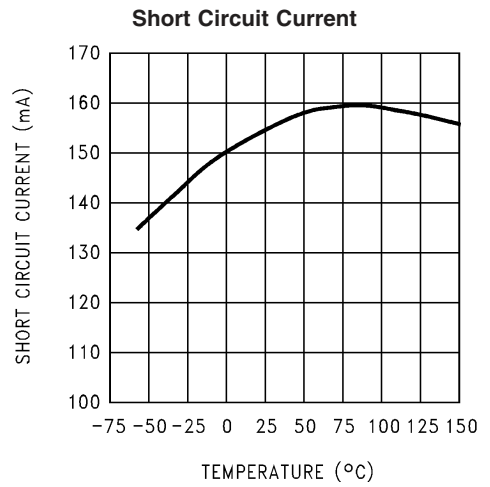

20052836

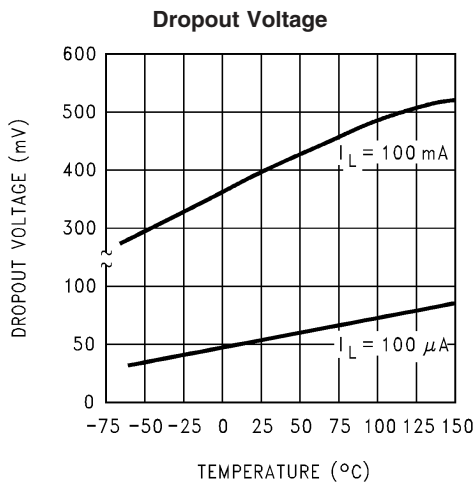

20052837

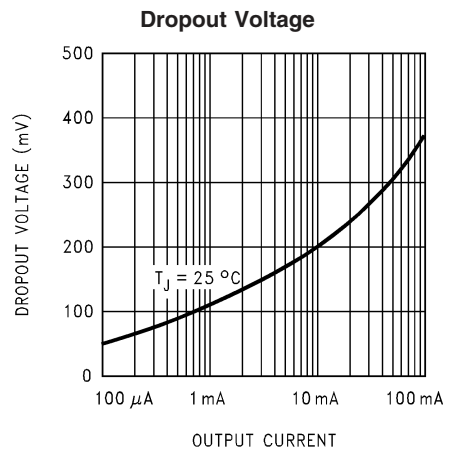

20052838

# Typical Performance Characteristics (Continued)

**LP4951C Minimum Operating Voltage**

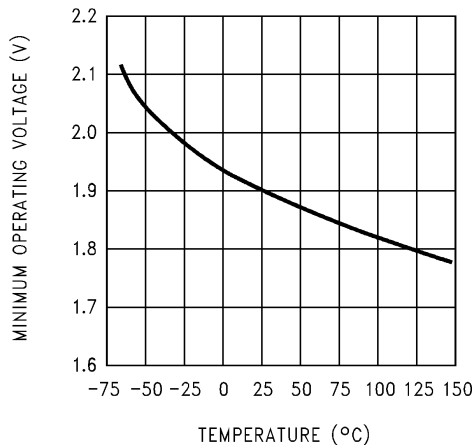

20052839

**LP4951C Feedback Bias Current**

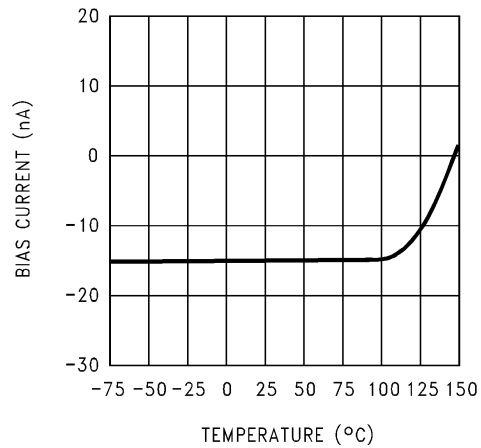

20052840

**LP4951C Feedback Pin Current**

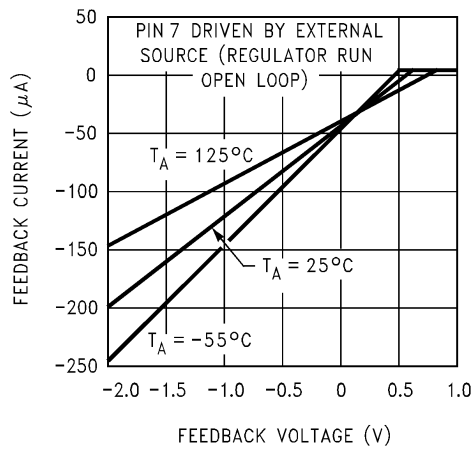

20052841

**LP4951C Error Comparator Output**

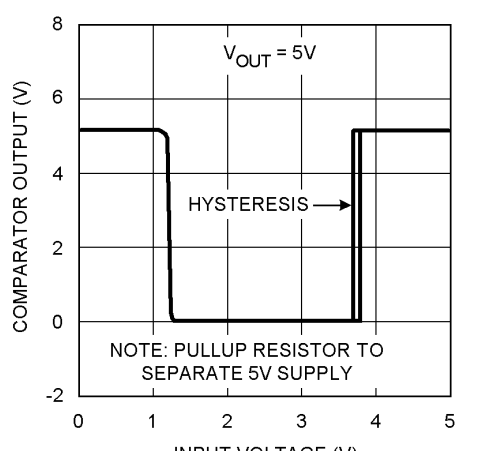

20052842

**LP4951C Comparator Sink Current**

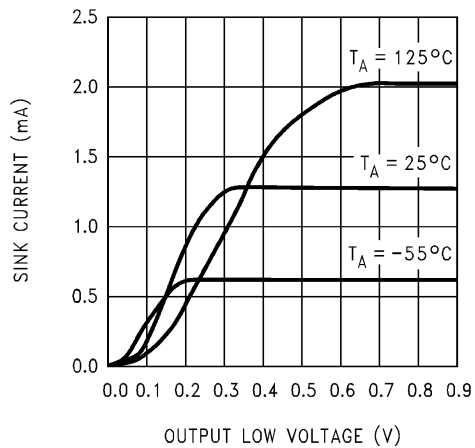

20052843

**Line Transient Response**

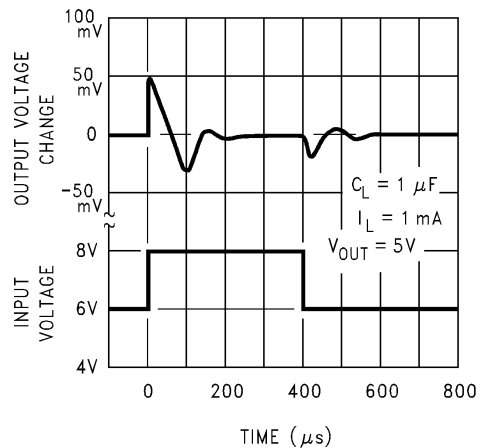

20052844

Typical Performance Characteristics (Continued)

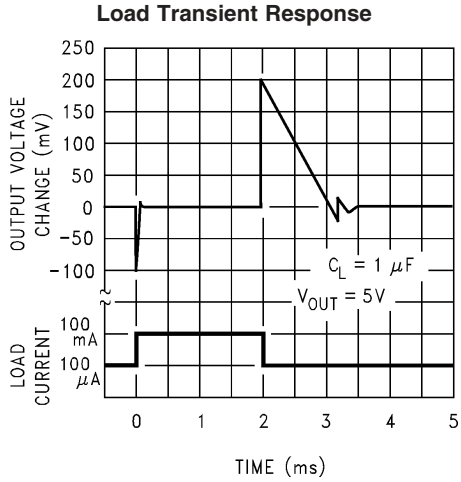

20052845

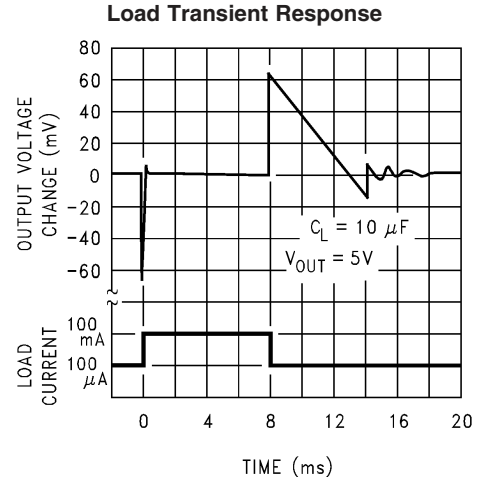

20052846

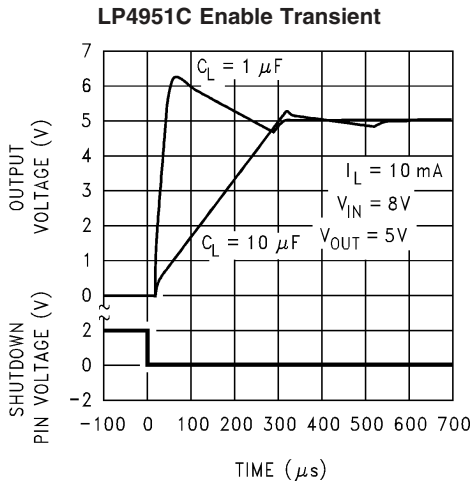

20052847

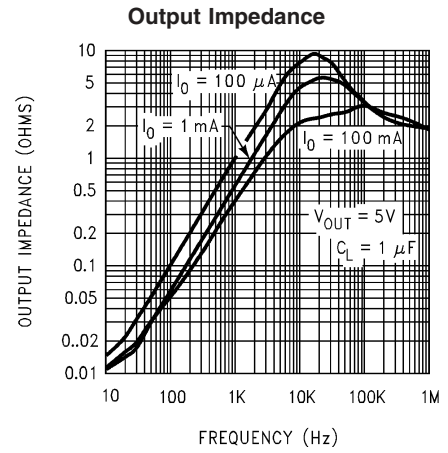

20052848

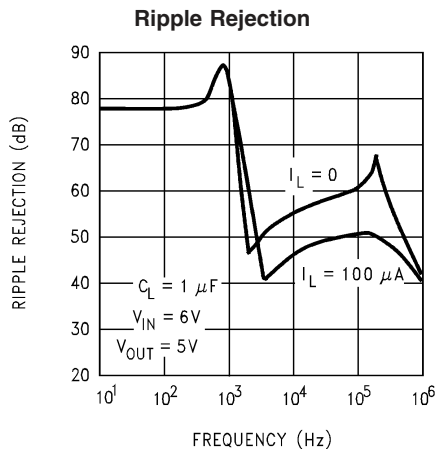

20052849

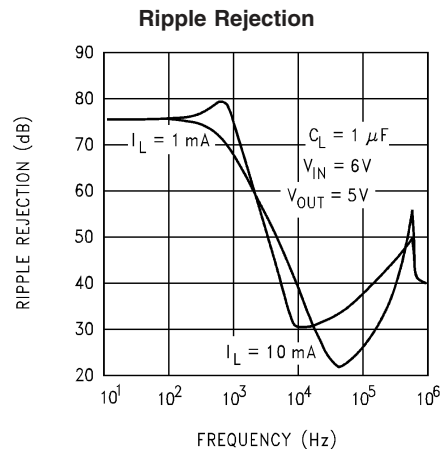

20052850



Typical Performance Characteristics (Continued)

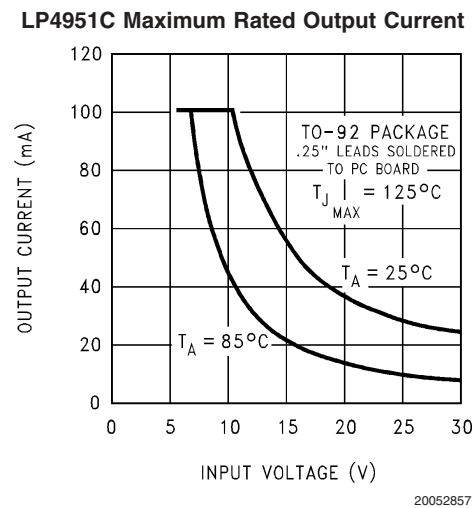
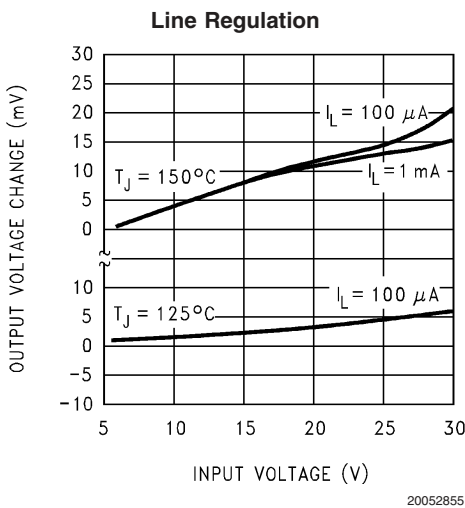
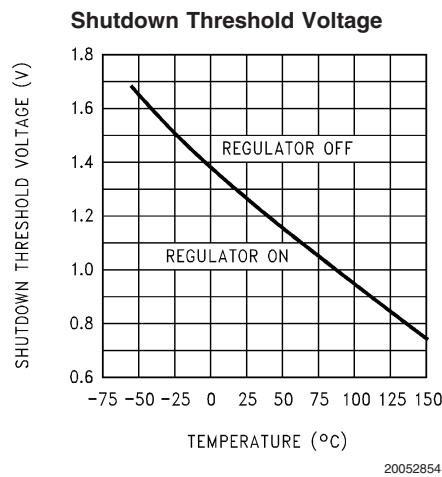
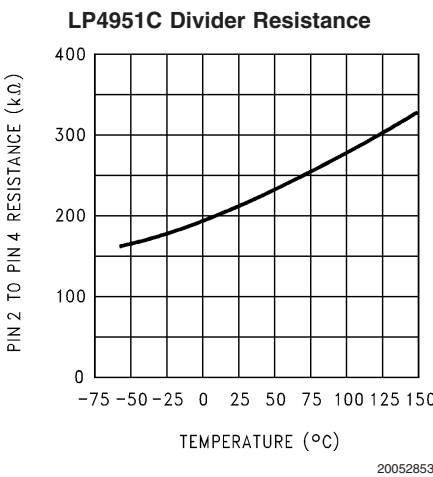
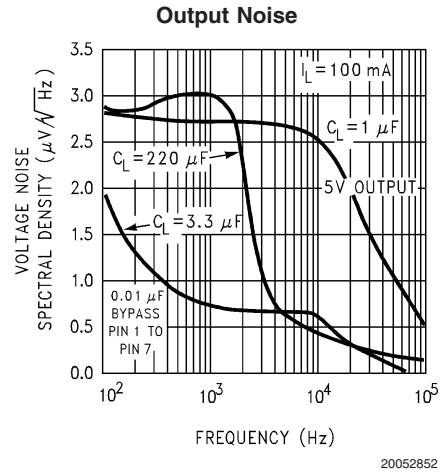
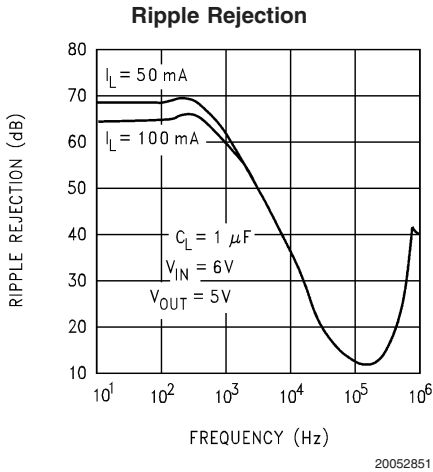

## Typical Performance Characteristics (Continued)

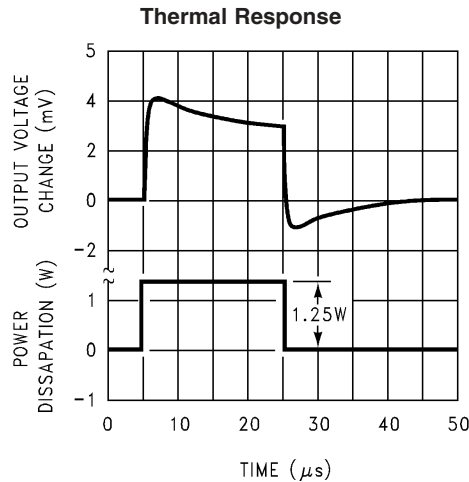

20052858

## Application Hints

### EXTERNAL CAPACITORS

A 1.0 $\mu\text{F}$  (or greater) capacitor is required between the output and ground for stability at output voltages of 5V or more. At lower output voltages, more capacitance is required. Without this capacitor the part will oscillate. Most types of tantalum or aluminum electrolytics work fine here; even film types work but are not recommended for reasons of cost. Many aluminum electrolytics have electrolytes that freeze at about  $-30^{\circ}\text{C}$ , so solid tantalums are recommended for operation below  $-25^{\circ}\text{C}$ . The important parameters of the capacitor are an ESR of about 5  $\Omega$  or less and a resonant frequency above 500 kHz. The value of this capacitor may be increased without limit.

At lower values of output current, less output capacitance is required for stability. The capacitor can be reduced to 0.33  $\mu\text{F}$  for currents below 10 mA or 0.1  $\mu\text{F}$  for currents below 1 mA. Using the 8-pin version at voltages below 5V runs the error amplifier at lower gains so that *more* output capacitance is needed. For the worst-case situation of a 100 mA load at 1.23V output (Output shorted to Feedback) a 3.3  $\mu\text{F}$  (or greater) capacitor should be used.

Unlike many other regulators, the LP4950C will remain stable and in regulation with no load in addition to the internal voltage divider. This is especially important in CMOS RAM keep-alive applications. When setting the output voltage of the LP4951C version with external resistors, a minimum load of 1 $\mu\text{A}$  is recommended.

A 0.1 $\mu\text{F}$  capacitor should be placed from the LP4950C/LP4951C input to ground if there is more than 10 inches of wire between the input and the AC filter capacitor or if a battery is used as the input.

Stray capacitance to the LP4951C Feedback terminal (pin 7) can cause instability. This may especially be a problem when using high value external resistors to set the output voltage. Adding a 100pF capacitor between Output and Feedback and increasing the output capacitor to at least 3.3 $\mu\text{F}$  will fix this problem.

### ERROR DETECTION COMPARATOR OUTPUT

The comparator produces a logic low output whenever the LP4951C output falls out of regulation by more than approximately 5%. This figure is the comparator's built-in offset of about 60 mV divided by the 1.235 reference voltage. (Refer to the block diagram in the front of the datasheet.) This trip level remains "5% below normal" regardless of the programmed output voltage of the 4951C. For example, the error flag trip level is typically 4.75V for a 5V output or 11.4V for a 12V output. The out of regulation condition may be due either to low input voltage, current limiting, or thermal limiting.

*Figure 1* below gives a timing diagram depicting the  $\overline{\text{ERROR}}$  signal and the regulated output voltage as the LP4951C input is ramped up and down. The  $\overline{\text{ERROR}}$  signal becomes valid (low) at about 1.3V input. It goes high at about 5V input (the input voltage at which  $V_{\text{OUT}} = 4.75\text{V}$ ). Since the LP4951C's dropout voltage is load-dependent (see curve in typical performance characteristics), the **input** voltage trip point (about 5V) will vary with the load current. The **output** voltage trip point (approx. 4.75V) does not vary with load.

The error comparator has an open-collector output which requires an external pullup resistor. This resistor may be returned to the output or some other supply voltage depending on system requirements. In determining a value for this resistor, note that while the output is rated to sink 400 $\mu\text{A}$ , this sink current adds to battery drain in a low battery condition. Suggested values range from 100k to 1 M $\Omega$ . The resistor is not required if this output is unused.

## Application Hints (Continued)

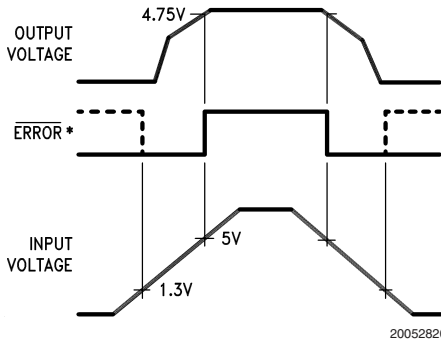

\*When  $V_{IN} \leq 1.3V$ , the error flag pin becomes a high impedance, and the error flag voltage rises to its pull-up voltage. Using  $V_{OUT}$  as the pull-up voltage (see Figure 2), rather than an external 5V source, will keep the error flag voltage under 1.2V (typ.) in this condition. The user may wish to divide down the error flag voltage using equal-value resistors (10 k $\Omega$  suggested), to ensure a low-level logic signal during any fault condition, while still allowing a valid high logic level during normal operation.

FIGURE 1.  $\overline{ERROR}$  Output Timing

### PROGRAMMING THE OUTPUT VOLTAGE (LP4951C)

The LP4951C may be pin-strapped for 5V using its internal voltage divider by tying the pin 1 (output) to pin 2 (sense) pins together, and also tying the pin 7 (feedback) and pin 6 ( $V_{TAP}$ ) pins together. Alternatively, it may be programmed for any output voltage between its 1.235V reference and its 30V maximum rating. As seen in Figure 2, an external pair of resistors is required.

The complete equation for the output voltage is

$$V_{OUT} = V_{REF} \cdot \left(1 + \frac{R_1}{R_2}\right) + I_{FB}R_1$$

where  $V_{REF}$  is the nominal 1.235 reference voltage and  $I_{FB}$  is the feedback pin bias current, nominally  $-20$  nA. The minimum recommended load current of  $1\mu A$  forces an upper limit of  $1.2$  M $\Omega$  on the value of  $R_2$ , if the regulator must work with no load (a condition often found in CMOS in standby).  $I_{FB}$  will produce a 2% typical error in  $V_{OUT}$  which may be eliminated at room temperature by trimming  $R_1$ . For better accuracy, choosing  $R_2 = 100k$  reduces this error to 0.17% while increasing the resistor program current to  $12\mu A$ . Since the LP4951C typically draws  $60\mu A$  at no load with Pin 2 open-circuited, this is a small price to pay.

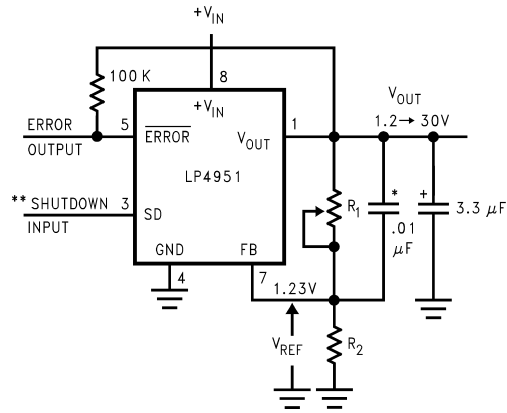

\*See Application Hints

$$V_{out} = V_{Ref} \left(1 + \frac{R_1}{R_2}\right)$$

\*\*Drive with TTL-high to shut down. Ground or leave open if shutdown feature is not to be used.

Note: Pins 2 and 6 are left open.

FIGURE 2. Adjustable Regulator (LP4951C)

### REDUCING OUTPUT NOISE

In reference applications it may be advantageous to reduce the AC noise present at the output. One method is to reduce the regulator bandwidth by increasing the size of the output capacitor. This is the only way noise can be reduced on the 3 lead LP4950C but is relatively inefficient, as increasing the capacitor from  $1\mu F$  to  $220\mu F$  only decreases the noise from  $430\mu V$  to  $160\mu V$  rms for a  $100kHz$  bandwidth at 5V output. Noise can be reduced fourfold by a bypass capacitor across  $R_1$ , since it reduces the high frequency gain from 4 to unity. Pick

$$C_{BYPASS} \cong \frac{1}{2\pi R_1 \cdot 200 \text{ Hz}}$$

or about  $0.01\mu F$ . When doing this, the output capacitor must be increased to  $3.3\mu F$  to maintain stability. These changes reduce the output noise from  $430\mu V$  to  $100\mu V$  rms for a  $100kHz$  bandwidth at 5V output. With the bypass capacitor added, noise no longer scales with output voltage so that improvements are more dramatic at higher output voltages.

Schematic Diagram

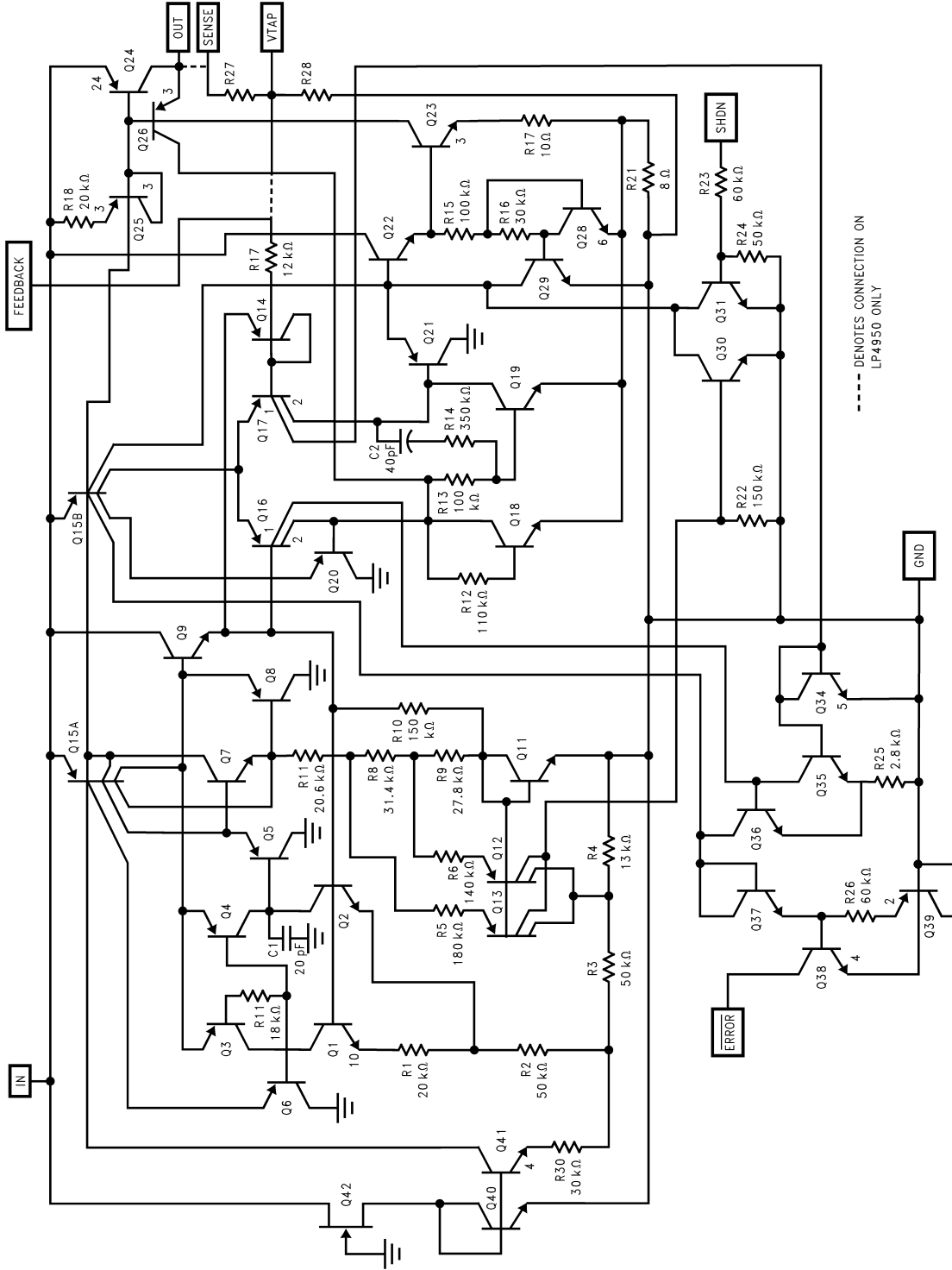

--- DENOTES CONNECTION ON LP4950 ONLY

**Physical Dimensions** inches (millimeters)

unless otherwise noted

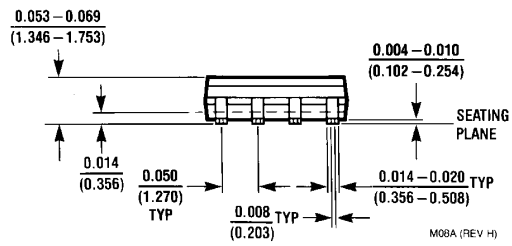
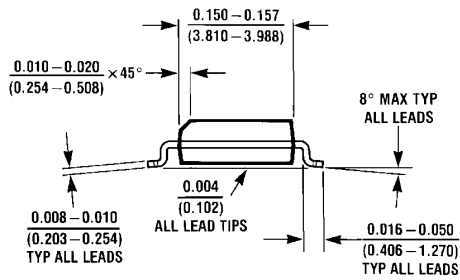
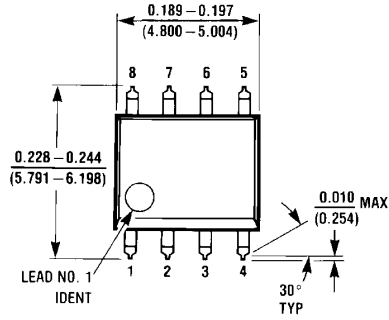

**Surface Mount Package (M)**  
NS Package Number M08A

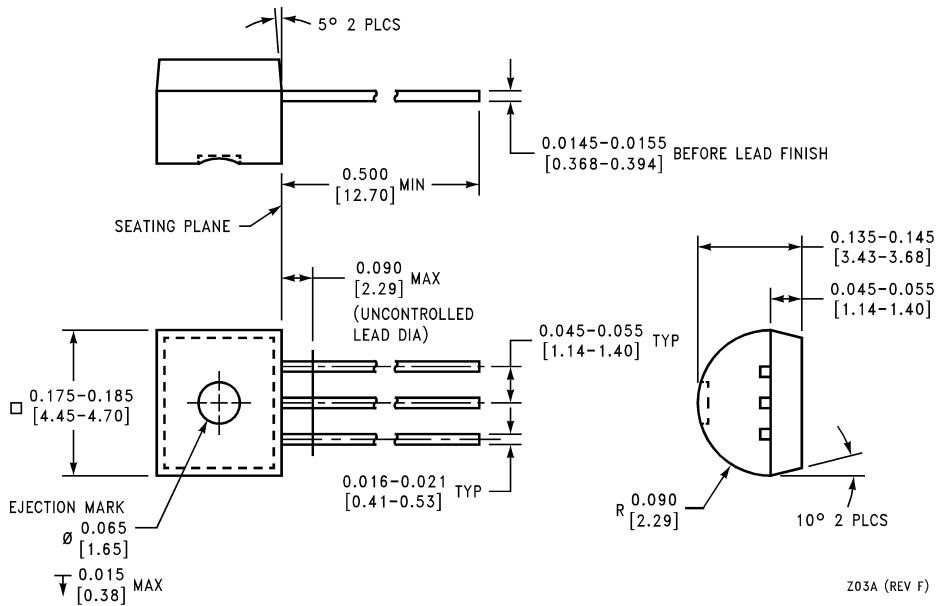

**Molded TO-92 Package (Z)**  
NS Package Number Z03A

## Notes

### LIFE SUPPORT POLICY

NATIONAL'S PRODUCTS ARE NOT AUTHORIZED FOR USE AS CRITICAL COMPONENTS IN LIFE SUPPORT DEVICES OR SYSTEMS WITHOUT THE EXPRESS WRITTEN APPROVAL OF THE PRESIDENT AND GENERAL COUNSEL OF NATIONAL SEMICONDUCTOR CORPORATION. As used herein:

1. Life support devices or systems are devices or systems which, (a) are intended for surgical implant into the body, or (b) support or sustain life, and whose failure to perform when properly used in accordance with instructions for use provided in the labeling, can be reasonably expected to result in a significant injury to the user.
2. A critical component is any component of a life support device or system whose failure to perform can be reasonably expected to cause the failure of the life support device or system, or to affect its safety or effectiveness.



**National Semiconductor Corporation**  
Americas  
Email: support@nsc.com

[www.national.com](http://www.national.com)

**National Semiconductor Europe**

Fax: +49 (0) 180-530 85 86  
Email: europe.support@nsc.com  
Deutsch Tel: +49 (0) 69 9508 6208  
English Tel: +44 (0) 870 24 0 2171  
Français Tel: +33 (0) 1 41 91 8790

**National Semiconductor Asia Pacific Customer Response Group**

Tel: 65-2544466  
Fax: 65-2504466  
Email: ap.support@nsc.com

**National Semiconductor Japan Ltd.**

Tel: 81-3-5639-7560  
Fax: 81-3-5639-7507